

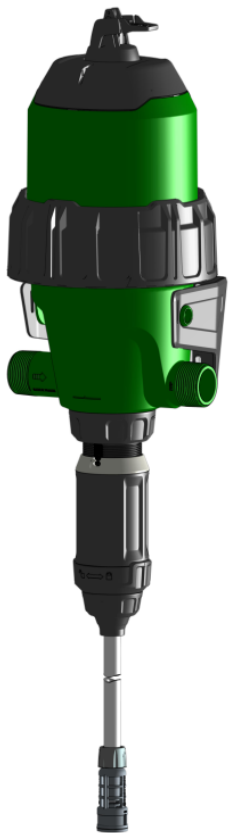

# **DOSATRON®**

*Because life is powered by water®*

**User manual**



**D6 - GREEN LINE**



# Contents

<b>INTRODUCTION</b> .....	<b>5</b>
<b>DOSATRON TECHNOLOGY</b> .....	<b>7</b>
<b>MARKING/IDENTIFICATION SPECIFICATIONS</b> .....	<b>11</b>
Markings .....	11
Codification of the part number .....	13
Specifications & Dimensions .....	14
Packaging .....	14
<b>INSTALLATION</b> .....	<b>15</b>
Precautions .....	15
Installing the DOSOTRON .....	18
Changing the dosing scale .....	20
Connecting the suction hose .....	22
Installation tips .....	23
<b>STARTING UP THE DOSATRON</b> .....	<b>25</b>
Using for the first time .....	25
Use .....	26
Adjusting the dosing rate (without pressure) .....	27
Dosing principle .....	27
<b>MAINTENANCE</b> .....	<b>29</b>
Recommendations .....	29
Draining the DOSATRON .....	30
Removing the suction hose .....	31
Removing/Refitting the injection assembly .....	32
Replacing the injection seals .....	33
Removing/Refitting the dosing piston .....	35
Cleaning and refitting the suction valve .....	36
Removing/Refitting the top cover (without pressure) .....	37
Replacing the motor piston (without pressure) .....	39
Removing/Refitting the motor sleeve (without pressure) .....	40
<b>TROUBLESHOOTING</b> .....	<b>41</b>

<b>WARRANTY .....</b>	<b>45</b>
<b>APPENDICES .....</b>	<b>47</b>
<b>Graphs.....</b>	<b>47</b>

# Introduction

This document does not form a contractual engagement and is for information purposes only. DOSATRON INTERNATIONAL reserves the right to modify its devices at any time. © DOSATRON INTERNATIONAL S.A.S 2024

**You have just acquired a DOSATRON water-powered dosing pump. Congratulations on your choice. This model was produced using over 50 years of experience.**

**Our engineers have developed the DOSATRON series to become one of the most technically advanced water-powered dosing pumps in the world.**

**Over time, this DOSATRON will prove itself to be a most faithful ally.**

**A few regular maintenance operations will guarantee operation in which the word “breakdown” will no longer be heard.**

**IT IS THEREFORE IMPORTANT TO READ THIS MANUAL CAREFULLY BEFORE USING THE DEVICE.**

**Important!**

**You will find your DOSATRON's part number and serial number on the pump body.**

**Please record these numbers in the space provided below for easy referral when contacting or requesting information from your vendor.**

**Part No. ....**

**Serial No. ....**

**Date of purchase .....**

This document does not form a contractual engagement and is for information purposes only. DOSATRON INTERNATIONAL reserves the right to modify its devices at any time.

**EC Declaration of Conformity**

This DOSATRON range complies with the European Directive 2006/42/EC.  
This declaration is only valid in countries where this directive applies.

# DOSATRON Technology

Unique technology that incorporates all dosing functions.

Installed on the water supply line, the DOSATRON uses water pressure as the only power source. When activated, it draws in the concentrate, doses it to the desired percentage, and mixes it with the motive water. The resulting solution is then propelled downstream. The dose of injected concentrate is always proportional to the volume of water flowing through the DOSATRON, regardless of variations in flow or pressure in the water supply line.

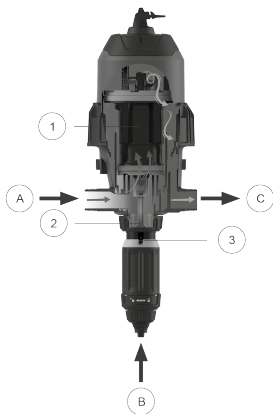

Item	Description
A	Clear water
B	Concentrated additive to be dosed
C	Solution water + % additive
1	Motor piston
2	Dosing piston
3	Dosing adjustment(%) <b>ratio</b>

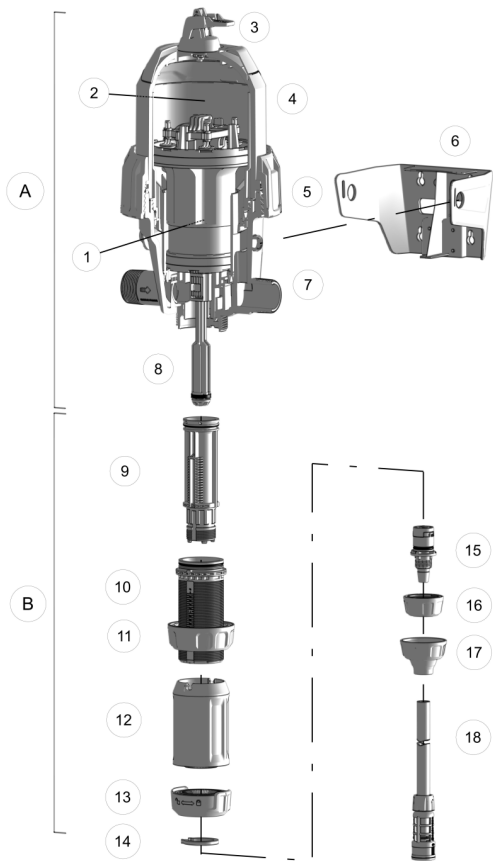

fig 1



Item	Description
A	MOTOR SECTION
B	INJECTION ASSEMBLY
1	Motor piston
2	Motor sleeve
3	Manual by-pass
4	Top cover
5	Top cover locking nut
6	Mounting bracket
7	Pump body
8	Dosing piston
9	Dosing pump body
10	Injector sleeve
11	Nut
12	Adjustment sleeve
13	Dosing locking ring
14	Retaining ring
15	Suction valve
16	Suction valve locking nut
17	Hose locking nut
18	(Ø16) Suction hose + strainer + ballast weight



# Marking/Identification Specifications

## MARKINGS

Your dosing pump has 3 main marking zones, allowing it to be identified in detail:

- A 2-line engraving on the side of the top cover with the exact part number of the device on the first line and the serial number on the second line.

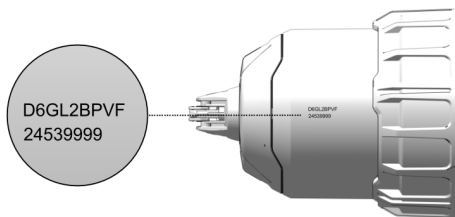

fig 2



## CODIFICATION OF THE PART NUMBER

PART No. .... Serial No.  
.....

Example	D6	GL	2	BP	VF
---------	----	----	---	----	----

Dosatron Range

Product line  
GL: Green Line

Dosing

BP: Manual By-pass  
option

Dosing Seal type  
VF: Acidic fluid

## SPECIFICATIONS & DIMENSIONS

Version	D6GL2
<b>Operating</b> flow range: 100 l/h min. 6 m <sup>3</sup> /h max. [0.44 - 26 US gpm]	
<b>Max. operating</b> temperature: ..... 40 °C [104 °F]	
<b>Operating</b> pressure:	
<b>bars</b>	0,3 - 8
psi	4.3 - 116
<b>Externally adjustable dosing rate:</b>	
%	0,2 - 2
Ratio	1:500 - 1:50
<b>Concentrated product injection rate:</b>	
<b>Min. l/h - Max. l/h</b>	0,2 - 120
US Fl. oz/min - MIN	0.112
US Fl. oz/min - MAX	67.6
<b>Connection</b> (NPT/BSP male gas fittings): ..... Ø33 x 42 mm [1 1/4"]	
<b>Hydraulic motor capacity</b> (every two clicks of the piston): approx. 1 l [0.264 US Gallons]	

**⚠ ATTENTION!** The DOSATRON is not pre-set, please refer to the paragraph on **Adjusting the dosing (without pressure)**, page 27

## DIMENSIONS

Diameter: <b>cm</b> ["]	<b>21</b> [8 1/2]
Total height: <b>cm</b> ["]	<b>64</b> [15 1/4]
Overall width: <b>cm</b> ["]	<b>21</b> [8 1/2]
Weight: <b>± kg</b> [lbs]	<b>3,7</b> [8,15]

## PACKAGING

### PACKAGE COMPOSITION:

1 DOSATRON/1 mounting bracket for DOSATRON/1 suction hose for concentrate/1 strainer/ 1 quick start guide

### PACKAGING DIMENSIONS:

63,6 x 22,4 x 22 cm [25 1/16" x 8 13/16" x 8 11/16"]

### PACKAGE WEIGHT:

Approx. 5 kg [~ 12 US lbs]

# Installation

## PRECAUTIONS

### 1. General points

**⚠ WARNING:** During the installation, operation and maintenance of the DOSATRON water-powered dosing pump, the following safety instructions must be observed: use suitable tools, protective clothing and safety goggles when working on the equipment and install it in such a way as to ensure risk-free operation.

**⚠ WARNING:** Follow the instructions in this manual and take safety measures appropriate to the nature of the liquid additives and the water temperature. Be extremely careful in the presence of hazardous substances (corrosives, toxic substances, solvents, acids, caustics, flammable substances, etc.). For dosing these substances, please consult your distributor before use to confirm compatibility with the dosing pump.

**⚠ ATTENTION!** The personnel in charge of installing, operating and maintaining this equipment must be fully acquainted with the contents of this manual.

- When connecting a DOSATRON either to the public water supply line or to its own water source, it is essential to adhere to the standards concerning protection and disconnection. DOSATRON recommends a shut off valve to prevent contamination of the water supply, where applicable.
- When connecting the DOSATRON to the water supply line, ensure that the water flows in the direction of the arrows shown on your device.
- If the system is located at a higher level than the DOSATRON itself, there is a possible risk of water and concentrate flowing back into the DOSATRON. We therefore recommend installing a non-return valve downstream of the device.
- Fitting an anti-siphoning valve downstream of the dosing pump is recommended in installations where there is a risk of siphoning.
- Do not install the DOSATRON above a tank containing aggressive additives. Move the can away and protect it from possible product fumes with a cover.
- Keep the DOSATRON away from significant heat sources and away from frost in the winter.
- In winter, or whenever the DOSATRON is exposed to temperatures close to or below 0°C, it must be protected from the cold and frost.

- Do not install the DOSATRON on the water pump suction circuit (risk of siphoning).
- The user is responsible for replacing the injection seals once a year to ensure accurate dosing.
- The adjustment of the Dosatron's dosing is the sole responsibility of the user. The user must strictly adhere to the recommendations of the chemical manufacturer.
- Ensure that the water flow and pressure of the installation are compliant with the DOSATRON specifications.
- The dosing should be adjusted with no pressure in the system. Turn off the water supply and allow the pressure to drop to zero.
- The user shall be solely responsible for correctly adjusting the DOSATRON to achieve the desired dosing rate.
- Problems with airtightness, impurities or chemical aggression of the seal can disrupt the dosing operation. We therefore recommend that you periodically check that the concentrate to be dosed is being correctly drawn into the DOSOTRON.
- Change the DOSATRON suction hose as soon as it appears to be damaged by the concentrate being dosed.
- Release the pressure in the system after use (recommended).
- The DOSOTRON must be rinsed:
  - whenever the concentrate is changed
  - before handling the DOSATRON, to avoid any contact with aggressive concentrates.
- All assembly and tightening operations must be done by hand and without the use of tools (except for those with recommended tightening torques).

## **2. Water with a high particle content**

If the water has a high abrasive particle content which could cause premature wear of the Dosatron, it is essential to install an upstream filter (e.g 60 microns - 250 mesh or finer).

## **3. Water hammer / Overflow**

- For installations subject to water hammer, a water hammer protection device must be fitted (pressure/flow control system).
- For automated installations, it is preferable to use slow opening and slow closing solenoid valves.
- If a DOSATRON is used to supply several sectors, activate the solenoid valves simultaneously (close one sector and open another sector at the same time).



#### **4. Installation location**

- The DOSATRON and the dosing additive must be accessible at all times. Their installation must under no circumstances present a pollution or contamination risk.
- It is recommended that all water pipes are marked showing that the water contains additives and with the wording: "CAUTION! Non-potable water" This wording will not be needed for drinking water applications.

#### **5. Maintenance**

- After use, we recommend flushing with clear water.
- Annual maintenance will extend the service life of your DOSATRON. Replace the dosing seals and the additive suction hose at least once a year.

#### **6. Service**

- This DOSATRON was tested prior to packaging.
- Replacement sub-assemblies and packs of seals are available upon request.
- Do not hesitate to call your distributor or DOSATRON for any after-sales services.

## INSTALLING THE DOSOTRON

**⚠ ATTENTION!** THE INSTALLATION SHOULD BE CARRIED OUT WITHOUT TOOLS

Remove the protective caps which block the openings in your DOSATRON, before connecting it to the water supply line.

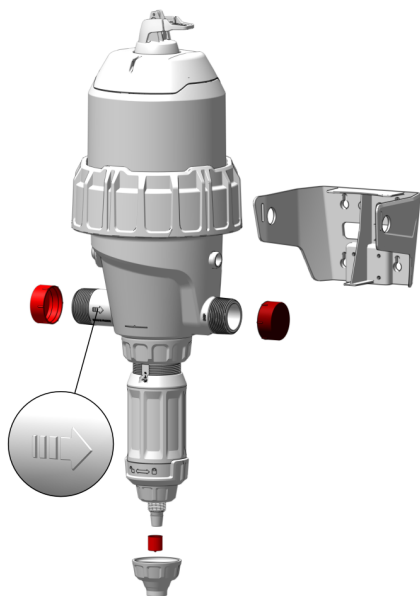

fig 5

The DOSATRON is delivered with:

- a mounting bracket,
- a suction hose with a strainer.

The mounting bracket enables the DOSATRON to be mounted on a wall.

Insert the DOSATRON into the mounting bracket, spreading the arms slightly so that the 2 centring pins on the main body engage in the corresponding holes in the mounting bracket.

Scan the QR code below with your smartphone. It will allow you to download the DOSATRON application, register your device and access a wide range of resources and information about your dosing pump.



## RECOMMENDATIONS

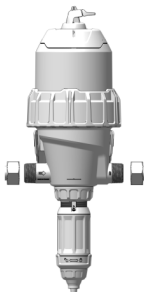

*fig 6*

Torque 30 N.m  
i.e. 3 kg.m  
(remember: 1 N.m = 0.1 DaN.m)

The device can be connected to the water supply line by means of 33 mm interior diameter flexible pipes (drinking water certified, where applicable) fixed with swivel fittings Ø 33 x 42 mm [1 1/4"]. Make sure that the water flows in the same direction as the arrows (water flow direction) on the device.

Whenever possible, install the DOSATRON high enough to be able to read and adjust the dosing on the graduated scale in % or ratio.

## CHANGING THE DOSING SCALE

The DOSATRON dosing rate can be adjusted according to two scales: percentages and ratios. These scales are positioned on either side of the injection assembly.

Depending on the liquid circulation direction in the hydraulic installation, and on the direction in which the dosing pump is mounted on its bracket, it may be necessary to change the orientation of this scale.

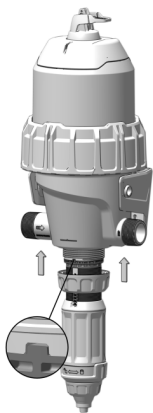

fig 7



fig 8

— Unscrew the fixing nut on the injection assembly by hand to release it, then pull it downwards and rotate it half a turn to see the correct dosing adjustment scale.



*fig 9*

— Ensure that the centring pins are aligned with the groove in the pump body. If necessary, to see the pins better, unscrew the dosing adjustment sleeve to the middle of its travel.

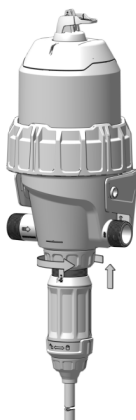

*fig 10*

— Manually retighten the fixing nut on the injection assembly.

## CONNECTING THE SUCTION HOSE

The DOSATRON is supplied with a suction hose (to be adjusted as required) which allows it to be used with a large capacity container. This hose must be fitted with the strainer and ballast.

**NOTA:** Maximum suction height: 4 m [13 ft]

### D6GL2



fig 11

- Unscrew the nut at the bottom of the injection assembly and thread the suction hose through the nut.



fig 12

Push the hose into the barbed fitting as far as it will go and screw the nut by hand.



fig 13

- Assemble the strainer on the other end of the hose using the same method

- Immerse the strainer into the solution to be dosed

## INSTALLATION TIPS

The DOSATRON must be assembled in by-pass as shown below. An in-line assembly is possible but not recommended because it does not enable the dosing pump to be easily isolated for maintenance (necessary to cut off the water supply).

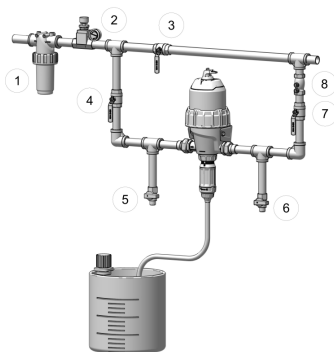

fig 14

Item	Description
1	Filter
2	Pressure reducer
3	By-pass valve
4 + 7	Isolation valves
5	Clear water / stock solution valve
6	Fast priming / flushing / Dosatron test / sampling valve
8	Non-return valve

To prolong the service life of the DOSATRON, we recommend fitting an upstream filter (e.g 60 microns - 250 mesh, depending on your water quality). This precaution is essential if the water contains impurities or particles, especially when using water from a well or surface water

The filter is recommended and required for the warranty to be valid.

**⚠ WARNING:** For any installation connected to the drinking water supply line, please respect the standards and regulations in force in your country.

**⚠ ATTENTION! OVERFLOW (for information purposes):** If your DOSOTRON clicks more than 50 times in 15 seconds, (i. e. 25 cycles) you have reached the upper limit of its flow capacity. If you want to increase the flow rate, please choose a DOSATRON with a higher water flow capacity.

**⚠ ATTENTION!** Leave the strainer approx. 10 cm [4"] from the bottom of the solution tank to avoid drawing in unsolvable particles that may damage the dosing pump body. The strainer must not rest on the bottom of the tank.

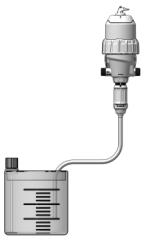

fig 15

#### WHAT YOU SHOULD DO

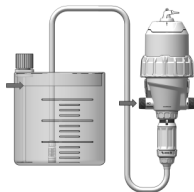

fig 16

#### WHAT YOU SHOULDN'T DO

Under no circumstances should the solution level be above the water inlet on the DOSATRON (to prevent siphoning).



# Starting up the DOSATRON

## USING FOR THE FIRST TIME

- Switch the by-pass to “ON”.
- Partially open the water inlet.
- Gradually open the DOSATRON By-Pass valves while closing the main valve, the Dosatron will prime itself.
- Let the DOSATRON run until the additive to be dosed rises in the injection assembly (you will be able to see it through the transparent tube).
- The Dosatron makes a characteristic “click-clack” noise when running.

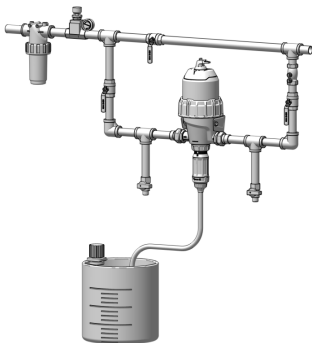

*fig 17*

The Dosatron is fitted with a by-pass function in its upper part as standard:

- When the by-pass is set to ON, the Dosatron runs and the additive is drawn up.
- When the by-pass is set to OFF, the DOSATRON stops and does not draw up the additive.

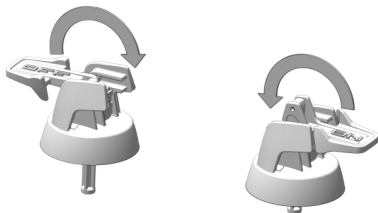

fig 18

**NOTA:** The time required to prime the dosed solution depends on the flow rate, the dosing setting and the length of the additive suction hose. To accelerate the priming, set the dosing level to maximum. Once the DOSATRON is primed, drop the pressure to zero and adjust to the required dosing value (please refer to the paragraph on [Adjusting the dosing \(without pressure\)](#), page 27).

## USE

The device is designed to operate with fluids whose temperature must not exceed 40 °C [104 °F] (motive fluid, additive, motive fluid/additive mixture). If the installation is subject to operating at temperatures lower than 5 °C [41 °F], ensure that the installation is protected from frost (please refer to the [Precautions](#), page 15 section).

The dosing pumps are designed for use at pressures of up to 8 bar [116 psi]. The installation must be protected against any risk of overpressure.

The installation must also be dimensioned to avoid hydraulic oscillation (water hammer).

If necessary, a water hammer protection device should be fitted.

## ADJUSTING THE DOSING RATE (WITHOUT PRESSURE)

**⚠ ATTENTION!** No tools should be used.

The dosing adjustment must be carried out with no pressure in the system

- Turn off the water supply and allow the pressure to drop to zero.
- Unscrew the dosing locking nut.
- Turn the dosing adjustment sleeve clockwise or anticlockwise so that the 2 dots above the viewing hole are aligned with the desired dosing marker.
- Retighten the dosing locking nut.



*fig 19*



*fig 20*



*fig 21*

## DOSING PRINCIPLE

Principle: Setting at 1% -  $1/100 = 1$  volume of concentrate to 100 volumes of water.



# Maintenance

**⚠ WARNING:** Before performing any work on the DOSATRON, you must read to the [Precautions section, page 15](#).

## RECOMMENDATIONS

1. We recommend periodically dismantling the entire injection assembly (refer to: [Cleaning and refitting the suction valve, page 36](#), [Replacing the injection seals, page 33](#)). Thoroughly rinse all elements of the injection assembly with clear water and reassemble them, having previously greased the seal (shown below) with a silicone-based lubricant.
2. Before restarting the DOSATRON at the start of the period of use, remove the motor piston and soak it in lukewarm water (<40 °C) for a few hours. This will remove any deposits that may have dried in the motor piston.



fig 22

## DRAINING THE DOSATRON

In order to perform thorough maintenance on the DOSATRON, or to protect it from frost, it may be necessary to drain it.

- Turn off the water supply and allow the pressure to drop to zero.
- Remove the injection assembly ( see [Removing/refitting the injection assembly, page 32](#)).
- Remove the top cover and the motor (see [Removing/Refitting the top cover \(without pressure\), page 37](#) and [Replacing the motor piston \(without pressure\), page 39](#)).
- Disconnect the water inlet and outlet connections.
- Empty the main body after removing it from the mounting bracket.
- Refit, once you have cleaned the motor cover seal



fig 23



fig 24

## REMOVING THE SUCTION HOSE

**⚠ WARNING:** Before performing any work on the DOSATRON, you must read to the [Precautions section, page 15](#).

**NOTA:** Before dismantling, and to avoid any contact with the injected additives, turn on the DOSATRON and allow it to draw in clear water in order to rinse the injection assembly.

### D6GL2

- Unscrew the nut at the bottom of the injection assembly
- Remove the hose from the suction valve fitting by pulling it downwards.
- Reassemble in the reverse order. If necessary, please refer to [Connecting the suction hose, page 22](#).



fig 25



fig 26

## REMOVING/REFITTING THE INJECTION ASSEMBLY

**⚠ WARNING:** Before performing any work on the DOSATRON, you must read to the [Precautions section, page 15](#).

**NOTA:** Before dismantling, and to avoid any contact with the injected additives, turn on the DOSATRON and allow it to draw in clear water in order to rinse the injection assembly.

- Turn off the water supply and allow the pressure to drop to zero.
- Remove the suction hose (see [Dismantling the suction hose, page 31](#)).
- Completely unscrew the fixing nut on the injection assembly
- Pull downwards to remove the injection assembly.
- Before refitting, position the injection assembly depending on the desired scale (percentage or ratio).
- Insert the injector sleeve into the pump body ensuring that the centring pins on the sleeve are aligned with the groove in the pump body. If necessary, to obtain a clearer view of the pins, unscrew the dosing adjustment sleeve to the middle of its travel.
- Manually retighten the fixing nut on the injection assembly



fig 27



fig 28



fig 29



## REPLACING THE INJECTION SEALS

Frequency: at least once a year.

Contact DOSATRON, or a dealer to select the appropriate seal kit for your dosing pump.

Dismantle the injection assembly in accordance with the instructions in the [Removing/Refitting the injection assembly section, page 32](#).

**⚠ ATTENTION! Do not use metal tools or utensils.**

### D6GL2

Replace the suction valve:

- Unscrew the suction valve locking nut.
- Release the suction valve by pulling it through the middle of the injection assembly

Replace the dosing pump body O-ring:

- Completely unscrew the dosing locking nut
- Release the snap ring by spreading the lugs.
- Remove the dosing body by pushing it through the sleeve
- Using your thumb and forefinger, pinch the component and the seal; push towards the other side to distort the seal.
- Continue until you can grip the protruding part of the seal, then pull it out of the groove.
- Refit the dosing pump body into the injector sleeve using the centring pins.
- Refit the snap ring, ensuring that it is correctly positioned in its groove.
- Retighten the dosing locking nut completely.
- Finish by refitting the suction valve and its locking nut.

Replace the injector sleeve O-ring:

- Follow the method explained above.

Replace the dosing piston seal:

- Replace the dosing pump body O-ring following the method described above.
- Clean the seal seating without any tools.
- Reassemble by hand. It is extremely important that the seal is not twisted once it is in place, as this would compromise the seal.



fig 30



fig 31



fig 32

## REMOVING/REFITTING THE DOSING PISTON

**⚠ WARNING:** Before performing any work on the DOSATRON, you must read to the [Precautions section, page 15](#).

**NOTA:** Before dismantling, and to avoid any contact with the injected additives, turn on the DOSATRON and allow it to draw in clear water in order to rinse the injection assembly.

- Turn off the water supply and allow the pressure to drop to zero.
- Dismantle the injection assembly in accordance with the instructions in the [Removing/Refitting the injection assembly section, page 32](#).

### D6GL2

- Turn the dosing piston through a quarter turn anticlockwise to unlock it and release it from the piston motor.
- Reassemble in the reverse order.

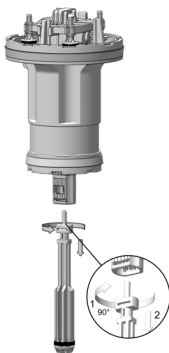

fig 33

## CLEANING AND REFITTING THE SUCTION VALVE

**⚠ WARNING:** Before performing any work on the DOSATRON, you must read to the [Precautions section, page 15](#).

**NOTA:** Before dismantling, and to avoid any contact with the injected additives, turn on the DOSATRON and allow it to draw in clear water in order to rinse the injection assembly.

- Turn off the water supply and allow the pressure to drop to zero.
- Remove the suction hose (see [Dismantling the suction hose, page 31](#)).
- Unscrew the suction valve locking nut.
- Release the suction valve by pulling it through the middle of the injection assembly
- Thoroughly rinse the various parts of the valve using clear water.
- Reassemble the parts following the order and positions shown in the diagram.

### D6GL2

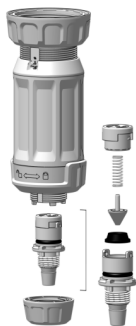
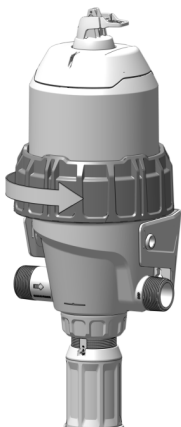

*fig 34*

## REMOVING/REFITTING THE TOP COVER (WITHOUT PRESSURE).

**⚠ WARNING:** Before performing any work on the DOSATRON, you must read to the [Precautions section, page 15](#).

**NOTA:** Before dismantling, and to avoid any contact with the injected additives, turn on the DOSATRON and allow it to draw in clear water in order to rinse the injection assembly.



*fig 35*

- Turn off the water supply and allow the pressure to drop to zero. Unscrew the top cover locking nut and remove it.

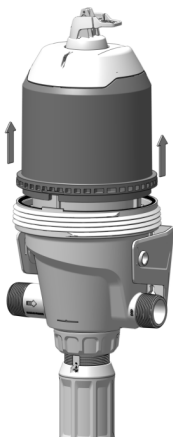

*fig 36*

- Remove the cover by lifting it upwards, taking care not to lose or damage the seal.

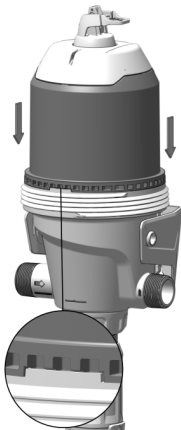

*fig 37*

- Replace the seal in the groove in the pump body. Position the top cover on the body, making sure that the groove on the top cover is properly aligned with the centre of the body.

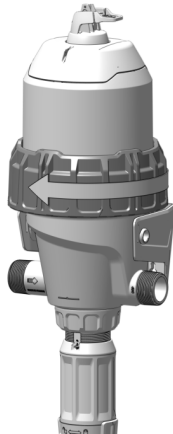

*fig 38*

- Retighten the top cover locking nut by hand.

## REPLACING THE MOTOR PISTON (WITHOUT PRESSURE)

**⚠ WARNING:** Before performing any work on the DOSATRON, you must read to the [Precautions section, page 15](#).

**NOTA:** Before dismantling, and to avoid any contact with the injected additives, turn on the DOSATRON and allow it to draw in clear water in order to rinse the injection assembly.

- Turn off the water supply and allow the pressure to drop to zero.
- Remove the top cover (see [Removing/Refitting the top cover, page 37](#)).
- Remove the motor piston assembly by pulling upwards.
- The rod and plunger piston will follow the motor piston upwards.
- Change and refit the assembly in the reverse order to dismantling.
- Refit the top cover.



*fig 39*

## REMOVING/REFITTING THE MOTOR SLEEVE (WITHOUT PRESSURE).

**⚠ WARNING:** Before performing any work on the DOSATRON, you must read to the [Precautions section, page 15](#).

**NOTA:** Before dismantling, and to avoid any contact with the injected additives, turn on the DOSATRON and allow it to draw in clear water in order to rinse the injection assembly.

- Turn off the water supply and allow the pressure to drop to zero.
- Remove the top cover (see [Removing/Refitting the top cover, page 37](#)).
- Remove the motor piston (see [Removing/Refitting the motor piston, page 39](#)).
- Unscrew the sleeve and remove it from the pump body, taking care not to lose or damage the seal.
- Reposition the sleeve inside the pump body. Tighten it until the marks on the body and the sleeve are perfectly aligned (see figure below).
- Refit the motor in the sleeve.
- Refit the top cover and tighten the locking nut.

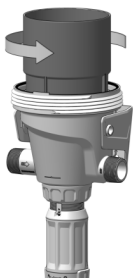

fig 40



fig 41



fig 42



# Troubleshooting

SYMPTOM	CAUSE	SOLUTION
<b>Motor piston</b>		
Your DOSATRON does not start or stops working.	The motor piston has seized.	Restart the motor piston by hand.
	Presence of air in the DOSATRON.	Bleed the air out of the system.
	Overflow.	1.Reduce the flow rate and restart. 2.Check that the motor valve seals are fitted.
	The motor piston is broken.	Return the DOSATRON to your distributor.
	The injector sleeve is scratched or damaged.	Replace the sleeve.
	The injector sleeve lip seals have been damaged by chemicals.	Replace the sleeve.
	The motor lip seals are worn.	Replace the motor lip seals.

SYMPTOM	CAUSE	SOLUTION
<b>Dosing</b>		
Under dosing	Air tightness problem.	1. Check that the injection assembly nuts are correctly tightened 2. Check the condition of the suction hose.
	The suction valve seal is worn or dirty.	Clean or replace it.
	Overflow (cavitation)	Reduce the flow rate.
	The plunger seal is worn	replace it
	The dosing pump body is scratched	Replace it.

SYMPTOM	CAUSE	SOLUTION
<b>Dosing</b>		
Additive is not being drawn into the system.	The motor piston has stopped working.	See Troubleshooting <a href="#">Motor piston</a> .
	Air tightness problem in the suction hose.	Check the suction hose and that its nuts are properly tightened.
	The suction hose is blocked or the strainer is clogged.	Clean or replace them.
	The suction valve seal is worn, incorrectly fitted or dirty.	Clean or replace it.
	The plunger seal is incorrectly fitted, dirty or swollen.	Clean or replace it.
	The dosing pump body is scratched.	Replace it.
Backflow into the product tank.	The suction valve or valve seal is dirty, worn or missing.	Clean or replace.
<b>Leaks</b>		
Leaks near the fixing nut under the pump body.	The dosing body seal is damaged, incorrectly positioned or missing.	Correctly position or replace it.
Leaks between the adjustment sleeve and the dosing locking nut.	The dosing pump body seal is damaged, incorrectly positioned or missing.	Correctly position or replace it.
Leaks between the body and the top cover.	The top cover seal is damaged, incorrectly fitted or missing	Position it correctly, clean the face of the seal or replace it.



# Warranty

DOSATRON INTERNATIONAL S.A.S. agrees to replace any part recognised as defective when new for a period of twelve months from the date of purchase by the initial purchaser.

To obtain the replacement under the warranty, the device or spare part must be returned with proof of initial purchase to the manufacturer or authorized distributor.

It may be recognised as defective after examination by the technical services of the manufacturer or distributor.

The device must be rinsed to remove any trace of chemicals and sent postage paid to the manufacturer or to the distributor. It will then be returned free of charge after repair if it is covered by the warranty.

Services rendered under the warranty cannot extend the duration thereof.

This warranty only applies to manufacturing defects.

This warranty does not cover any defects resulting from abnormal installation, the use of unauthorized tools, incorrect installation, improper maintenance, environmental accidents, or corrosion caused by foreign objects or liquids found in or near the device.

When dosing aggressive products, please consult your vendor before use to confirm compatibility with the dosing pump.

This warranty does not cover seals (wearing parts) or any damage caused by water-borne impurities such as sand.

A filter (e.g 60 microns - 250 mesh, depending on your water quality) must be installed upstream of the device for this warranty to be valid.

DOSATRON INTERNATIONAL S.A.S. declines all responsibility if the device is used in conditions that do not comply with the requirements and tolerances specified in the user manual.

There is no express or implied warranty with respect to other products or accessories used in conjunction with DOSATRON INTERNATIONAL S.A.S. devices.

## KNOW YOUR FLOW

A SIMPLE METHOD  
THE DOSATRON IS COMPOSED OF:

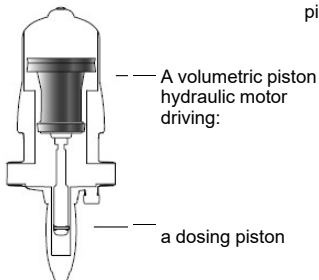

As it moves back and forth, the motor piston clicks:

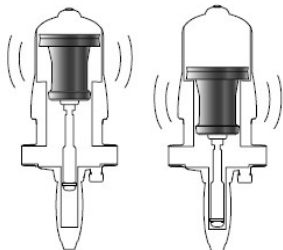

2 clicks = 1 motor  
cycle = 1 displacement

Once in the up  
position

Once in the  
down position

The speed of the motor is proportional to the flow of water passing through the device.

**Calculating the water flow rate in litres/hour =**

$$\frac{\text{Number of clicks in 15 seconds}}{2} \times 4 \times 60 \times 1$$

Calculation for 1 minute

Motor displacement in litres

2 clicks = 1 cycle

Calculation for 1 hour

**Calculating the water flow rate in gallons/minute =**

$$\frac{\text{Number of clicks in 15 seconds}}{2} \times 4 \times 1 \times 3.8$$

Calculation for 1 minute

Conversion litres to gallons

Motor displacement in litres

2 clicks = 1 cycle

# Appendices

## GRAPHS

# 1. Pressure losses - D6 - 2%

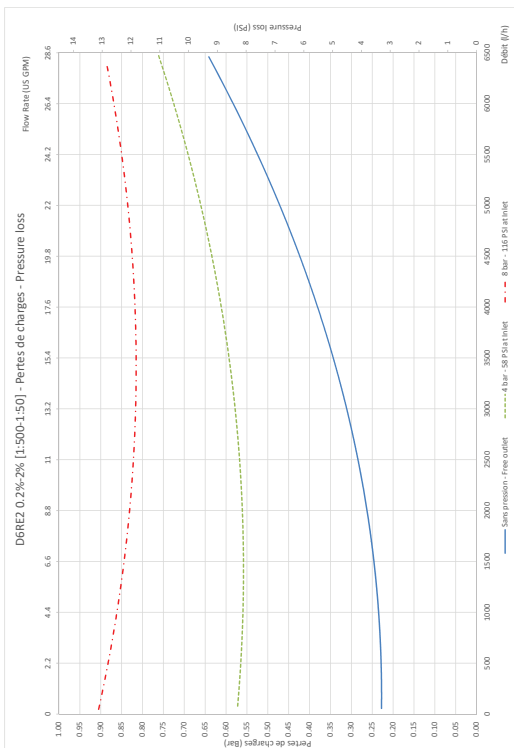

fig 43



## 2. Viscosity - D6 - 2%

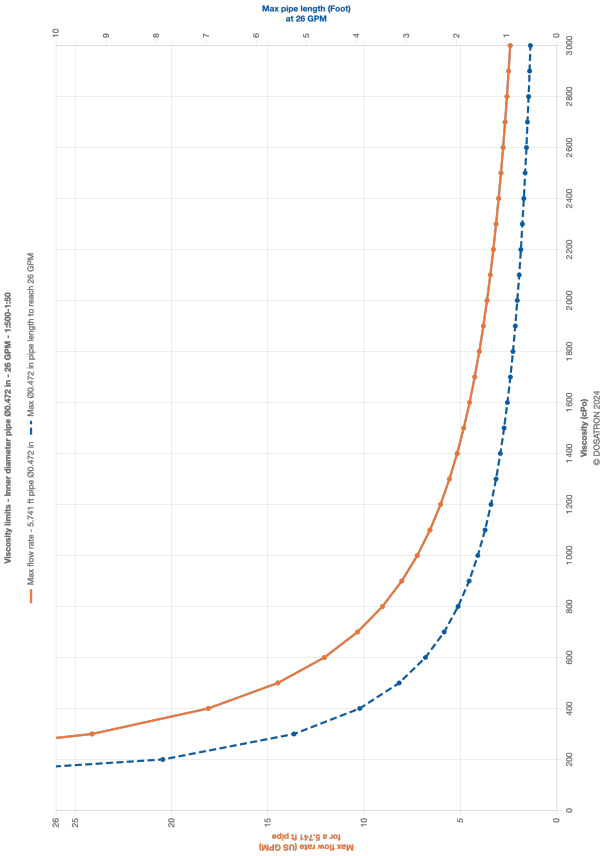

fig 44



# **DOSATRON®**

*Because life is powered by water®*

Download our  
**DOSATRON**  
app



 **App Store**

 **Google play**

**MADE BY**

**DOSATRON INTERNATIONAL S.A.S.**

Rue Pascal - B.P. 6 - 33370 TRESSES (BORDEAUX) - FRANCE

**Phone: 33 (0)5 57 97 11 11**

**Fax. 33 (0)5 57 97 11 29 / 33 (0)5 57 97 10 85**

**info@dosatron.com - www.dosatron.com**

© DOSATRON INTERNATIONAL S.A.S. 2024

Certified QEH&S System

